



Current transformers
DM0T0060

Product designation

Product type designation

Auxiliary supply U_s

Operational frequency

min	Hz	50
max	Hz	60

Current inputs

Primary current I_{pn} (/5) A 60

Secondary output current A 5

Overload withstand I_{pn} % 120

Burden

cl. 1	VA	1.5
-------	----	-----

Insulations

Rated insulation voltage U_i IEC/EN V 720

IEC rated short-time thermal current I_{th} I_{th} for s 40...60

IEC rated dynamic current I_{dyn} I_{th} for s 2.5

Insulation dry type Class E

Mechanical features

Terminals type Screw

Fixing DIN rail or by Screw

Weight g 200

Ambient conditions

Temperature

Operating temperature

min	°C	-25
max	°C	+50

Storage temperature

min	°C	-40
max	°C	+80

Relative humidity % 90

Protection degree IP30

Dimensions

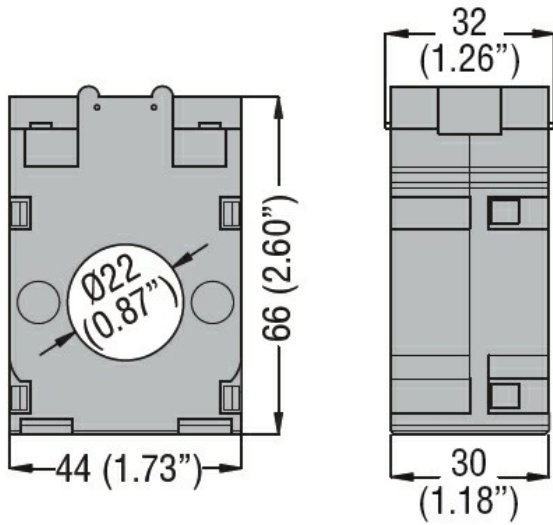

Certifications and compliance

Compliance

IEC/EN/BS 61869-1

IEC/EN/BS 61869-2

Certificates

EAC

GOST

ETIM classification

ETIM 8.0

EC002048 -
 Current
 transformer